



**An Analysis of Magnesium Alloy AZ31B-H24
for Ballistic Applications**

by Tyrone L. Jones, Matthew S. Burkins, and William A. Gooch

ARL-TR-4327

December 2007

NOTICES

Disclaimers

The findings in this report are not to be construed as an official Department of the Army position unless so designated by other authorized documents.

Citation of manufacturer's or trade names does not constitute an official endorsement or approval of the use thereof.

DESTRUCTION NOTICE—Destroy this report when it is no longer needed. Do not return it to the originator.

Army Research Laboratory

Aberdeen Proving Ground, MD 21005-5066

ARL-TR-4327

December 2007

An Analysis of Magnesium Alloy AZ31B-H24 for Ballistic Applications

Tyrone L. Jones, Matthew S. Burkins, and William A. Gooch
Weapons and Materials Research Directorate, ARL

REPORT DOCUMENTATION PAGE			<i>Form Approved</i> <i>OMB No. 0704-0188</i>		
Public reporting burden for this collection of information is estimated to average 1 hour per response, including the time for reviewing instructions, searching existing data sources, gathering and maintaining the data needed, and completing and reviewing the collection information. Send comments regarding this burden estimate or any other aspect of this collection of information, including suggestions for reducing the burden, to Department of Defense, Washington Headquarters Services, Directorate for Information Operations and Reports (0704-0188), 1215 Jefferson Davis Highway, Suite 1204, Arlington, VA 22202-4302. Respondents should be aware that notwithstanding any other provision of law, no person shall be subject to any penalty for failing to comply with a collection of information if it does not display a currently valid OMB control number.					
PLEASE DO NOT RETURN YOUR FORM TO THE ABOVE ADDRESS.					
1. REPORT DATE (DD-MM-YYYY) December 2007		2. REPORT TYPE Final		3. DATES COVERED (From - To) March through October 2007	
4. TITLE AND SUBTITLE An Analysis of Magnesium Alloy AZ31B-H24 for Ballistic Applications			5a. CONTRACT NUMBER		
			5b. GRANT NUMBER		
			5c. PROGRAM ELEMENT NUMBER		
6. AUTHOR(S) Tyrone L. Jones, Matthew S. Burkins, and William A. Gooch (all of ARL)			5d. PROJECT NUMBER 1L162618AH80		
			5e. TASK NUMBER		
			5f. WORK UNIT NUMBER		
7. PERFORMING ORGANIZATION NAME(S) AND ADDRESS(ES) U.S. Army Research Laboratory Weapons and Materials Research Directorate Aberdeen Proving Ground, MD 21005-5067			8. PERFORMING ORGANIZATION REPORT NUMBER ARL-TR-4327		
9. SPONSORING/MONITORING AGENCY NAME(S) AND ADDRESS(ES)			10. SPONSOR/MONITOR'S ACRONYM(S)		
			11. SPONSOR/MONITOR'S REPORT NUMBER(S)		
12. DISTRIBUTION/AVAILABILITY STATEMENT Approved for public release; distribution is unlimited.					
13. SUPPLEMENTARY NOTES					
14. ABSTRACT The U.S. Army Research Laboratory is developing a ballistic specification for the use of magnesium alloy AZ31B-H24 as armor on Army platforms. Data were generated for a range of thicknesses of this magnesium alloy, 0.25 to 4 inches, with the use of five different projectiles. The magnesium performance is parametrically quantified on an equivalent areal density to meet the aluminum alloy 5083-H131, which means a mature, well defined, low-density metal. The results show that the performance of magnesium depends on the diameter of the threat. This research sets a baseline ballistic performance for magnesium alloy AZ31B-H24 for quality control purposes and for use in the development and evaluation of improved alloys.					
15. SUBJECT TERMS aluminum; armor; AZ31B; ballistic performance; magnesium; 5083					
16. SECURITY CLASSIFICATION OF:			17. LIMITATION OF ABSTRACT SAR	18. NUMBER OF PAGES 20	19a. NAME OF RESPONSIBLE PERSON Tyrone L. Jones
a. REPORT UNCLASSIFIED	b. ABSTRACT UNCLASSIFIED	c. THIS PAGE UNCLASSIFIED			19b. TELEPHONE NUMBER (Include area code) 410-278-6223

Contents

List of Figures	iv
List of Tables	iv
1. Introduction	1
2. Projectiles	1
2.1 Armor-Piercing (AP) Projectiles	1
2.2 Fragment-Simulating Projectiles (FSPs).....	2
3. Magnesium Armor Solutions	2
4. Conclusions	6
5. References	7
Distribution List	8

List of Figures

Figure 1. M2 AP projectiles.....	1
Figure 2. Normalized FSPs (3).....	2
Figure 3. Estimated V_{50} ballistic limit of the .30-caliber M2 AP.....	4
Figure 4. Estimated V_{50} ballistic limit of the .50-caliber M2 AP.....	4
Figure 5. Estimated V_{50} ballistic limit of the .22-caliber FSP.....	5
Figure 6. Estimated V_{50} ballistic limit of the .50-caliber FSP.....	5
Figure 7. Estimated V_{50} ballistic limit of the 20-mm FSP.....	6

List of Tables

Table 1. M2 AP projectile dimensions and masses.....	2
Table 2. General mechanical properties (3).....	3
Table 3. AZ31B tensile properties (3).....	3
Table 4. Brinell hardness properties.....	3

1. Introduction

The U.S. Army Research Laboratory (ARL) has continued to expand the magnesium database for the purpose of creating a military specification for magnesium alloy AZ31B-H24. The favorable mechanical properties of this commercially available alloy have been documented in earlier work (1). The purpose of this document is to parametrically compare the ballistic effectiveness, on a weight basis, of the moderate strength, excellent damper AZ31B-H24 to the moderate strength, excellent ductility aluminum alloy 5083-H131. Data for 5083-H131 were obtained from military specification MIL-DTL-46027J(MR) (2).

2. Projectiles

2.1 Armor-Piercing (AP) Projectiles

The two projectiles of interest are the U.S. .30-cal M2 AP and the U.S. .50-cal M2 AP, as documented in MIL-DTL-46027J(MR). The U.S. .30-cal projectile contains a hardened steel core that has a hardness of Rockwell C60-65 (3). The core has a lead filler encased in a full metal jacket, as shown in figure 1; the lead filler is in front and back of this core. The U.S. .50-cal M2 AP, also shown in figure 1, is similar to the .30-cal M2 AP with size and weight differences and lead filler only in front of this core. The projectile contains a hardened steel core that has a hardness of Rockwell C60-65. The projectile dimensions and masses are listed in table 1.



Figure 1. M2 AP projectiles.

Table 1. M2 AP projectile dimensions and masses.

	.30-cal M2 AP (4)	.50-cal M2 AP
Length (mm)	35.6	57.9
Diameter (mm)	7.84	12.9
Projectile (g)	10.6	40.1
Core (g)	5.2	25.9
Nose (g)	1.3	3.6
Jacket (g)	4.2	16.3

2.2 Fragment-Simulating Projectiles (FSPs)

FSPs manufactured to meet the specifications of MIL-DTL-46593B (MR) (5) are used for the ballistic evaluation of 5083-H131 to meet the MIL-DTL-46027J(MR) specification. These projectiles are steel, right circular cylinders with a chiseled nose at the front end. The other end features an obturator flange. The .22-cal, .50-cal, and 20-mm FSPs were used to evaluate AZ31B-H24. Figure 2 details the shape and dimensions of each FSP.

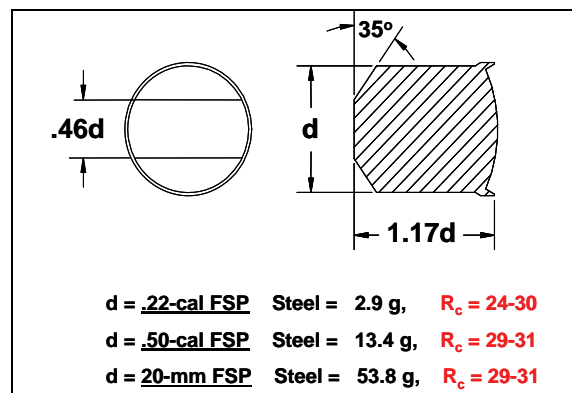

Figure 2. Normalized FSPs (3).

3. Magnesium Armor Solutions

The general mechanical properties of AZ31B-H24 magnesium, 5083-H131 aluminum, and rolled homogeneous armor (RHA) steel are provided for comparison in table 2. The tensile and Brinell hardness¹ properties for different tempers of AZ31B are provided in tables 3 and 4. A softer temper, AZ31B-O and a high strength experimental alloy, E675 were evaluated to assess the effect of strength on ballistic performance against some projectiles. The V_{50} ² protection ballistic limit

¹Brinell hardness is the load used to force a hardened sphere into a metal surface divided by the area of the indentation created in the surface.

² V_{50} is the velocity at which there is an equal probability of a partial or a complete perforation for the given armor and threat.

velocity of the metal plates was statistically determined following the standards of MIL-STD-662F (6). The magnesium data will be used to generate a military armor specification for AZ31B-H24.

Figures 3 through 7 provide the ballistic V_{50} limit velocity data for the plates as a function of areal density (weight per unit area; thickness times density) for the various projectiles.

Table 2. General mechanical properties (3).

Property	AZ31B	RHA	AL5083
Density (g/cm ³)	1.77	7.86	2.66
Ultimate Tensile Strength (MPa)	270	1170	350
Young's Modulus (GPa)	44	205	70
Specific Strength (MPa•cm ³ /g)	153	150	130
Specific Modulus (GPa•cm ³ /g)	24.9	26.1	26.3

Table 3. AZ31B tensile properties (3).

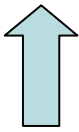
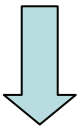
Relative Strength	Magnesium Alloy-Temper	Ultimate Tensile Strength		Tensile Yield Strength		ETF	Relative Ductility
		ksi	MPa	ksi	MPa	percent	
	AZ31B-H24	39	269	27	186	9	
	ZK10-F	37	255	27	186	10	
	AZ31B-O	36	248	21	145	12	
	AZ31B-O "Super Annealed"	35	241	19	131	14	

ETF = elongation to failure; ksi = kilopounds per square inch; MPa = megapascals

"Super annealed" AZ31B-O was created by precipitation hardening at 700 °F for 2 hours. We then cooled it to room temperature by decreasing the oven set point by 50 °F per hour.

Table 4. Brinell hardness properties.

Magnesium Alloy-Temper	Hardness ^a (HBN)
AZ31B-H24	61.0
AZ31B-F	59.0
AZ31B-O	54.0
AZ31B-O super annealed	33.6

^aTested on 500-kg Brinell scale

The limit velocities shown are acceptance velocities from MIL-DTL-46027J and actual test V_{50} for AZ31B. The AP ballistic performance data show AZ31B to be very similar in mass efficiency against these projectiles. The increased thickness of the monolithic AZ31B did not improve the overall ballistic performance. The FSP ballistic performance data show that at thinner gauge monolithic plate, the AZ31B outperforms 5083AL. The thickness of the plate is more of a factor than the strength at the lower areal densities. There is a cross-over, which depends on the threat diameter, where the strength surpasses the thickness and becomes the dominant factor in the overall ballistic performance. It is also clear that strength is more of a factor against the flat-headed high-energy FSPs than AP projectiles. In addition, the excellent ductility of 5083AL relocates some of the kinetic energy of the FSP into plastic deformation. Experimental observation

revealed that more ductility in AZ31B could improve the back face spalling and thus the ballistic performance of the plate. Hardness was not a factor for AZ31B against the AP core and FSP cylinder since the projectiles remained fully intact after impact. Hardness was not a factor for 5083AL against the AP core that remained fully intact. However, hardness was a small factor for 5083AL against the FSP cylinder since the projectile slightly mushroomed after impact.

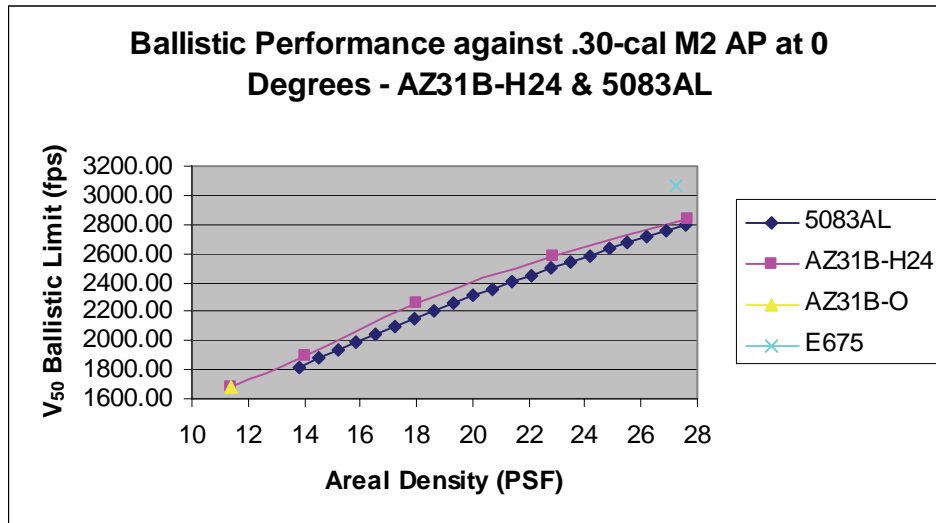

Figure 3. Estimated V_{50} ballistic limit of the .30-caliber M2 AP.

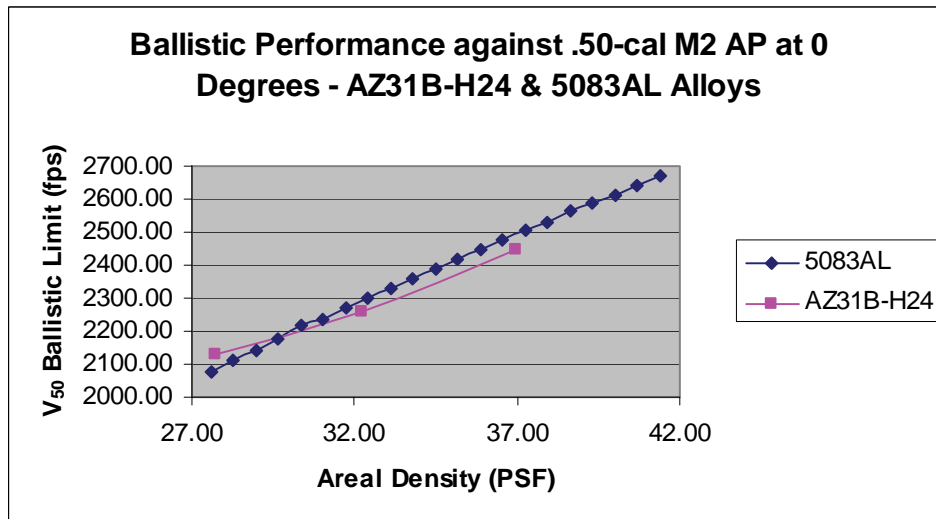

Figure 4. Estimated V_{50} ballistic limit of the .50-caliber M2 AP.

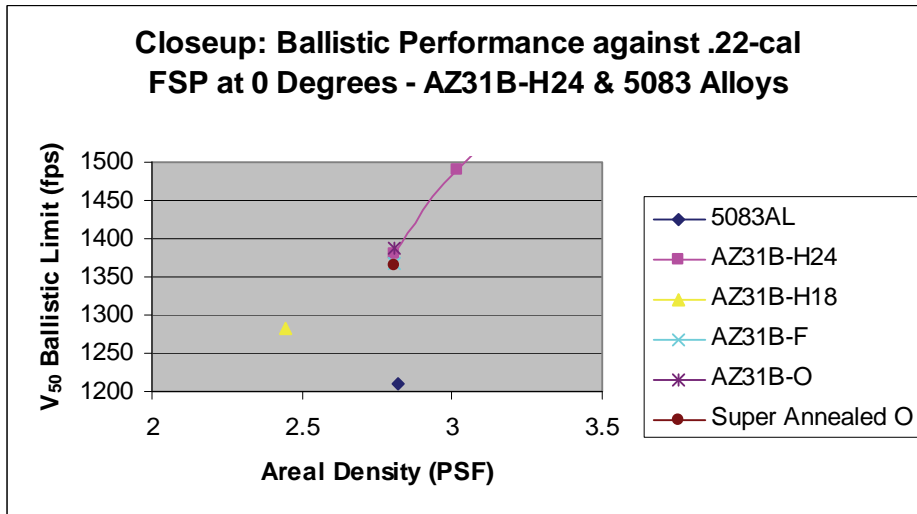
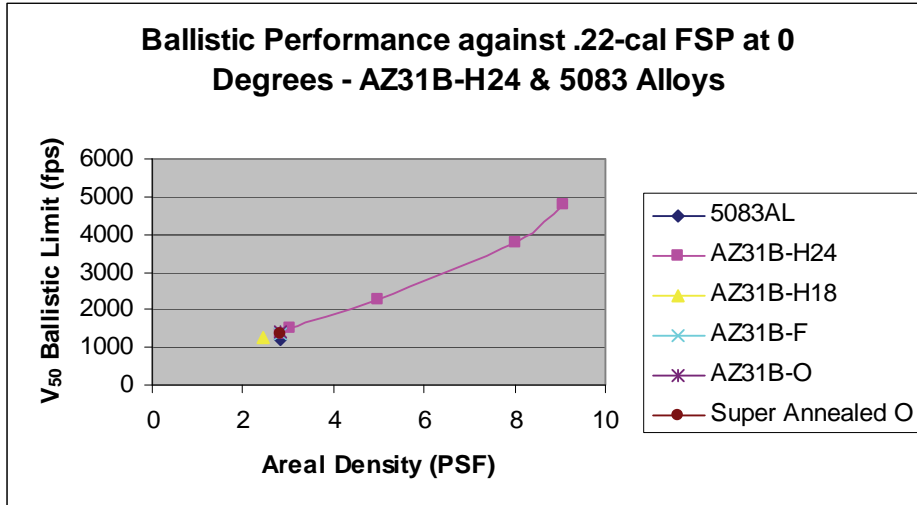

Figure 5. Estimated V₅₀ ballistic limit of the .22-caliber FSP.

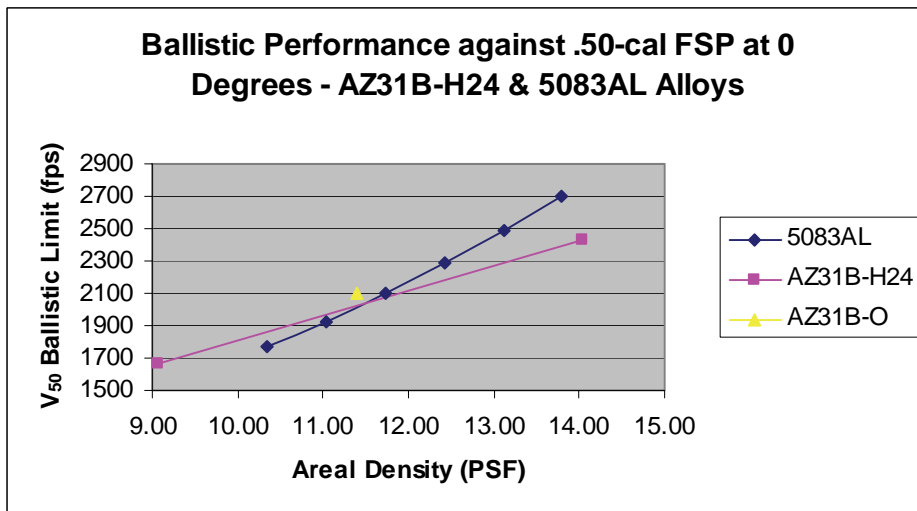

Figure 6. Estimated V₅₀ ballistic limit of the .50-caliber FSP.

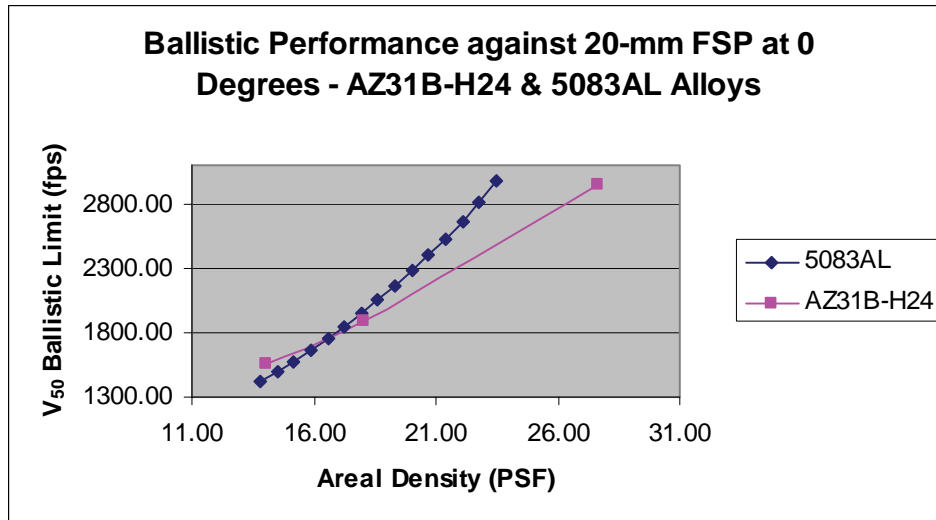

Figure 7. Estimated V₅₀ ballistic limit of the 20-mm FSP.

4. Conclusions

AZ31B-H24 is competitive to 5083-H131 aluminum armor on an equivalent weight basis. This magnesium has a better ballistic performance than 5083-H131 against the AP projectiles while 5083-H131 offers better fragment protection. The spall strength of AZ31B might be improved with alloying. The cost of AZ31B-H24 is currently \$7 to \$8 per pound versus for \$2.50 to \$3 per pound for 5083-H131. ARL is currently working on the generation of a military armor specification that will allow armor system manufacturers to qualify their magnesium material for use in combat vehicles.

5. References

1. Jones, T. L.; DeLorme, R. D.; Burkins, M. S.; Gooch, W. A. *Ballistic Evaluation of Magnesium Alloy AZ31B*; ARL-TR-4077, U.S. Army Research Laboratory: Aberdeen Proving Ground, MD, April 2007.
2. U.S. Army Research Laboratory. *Armor Plate, Aluminum Alloys. Weldable 5083 and 5456*, Military Specification MIL-DTL-46027J (MR), Aberdeen Proving Ground, MD, 04 September 1998.
3. Jones, T. L.; DeLorme, R. D.; Burkins, M. S.; Gooch, W. A. *Ballistic Performance of Magnesium Alloys*, PowerPoint Presentation. *TMS 2007 Annual Meeting & Exhibition*, Orlando, FL, 25 March 2007.
4. Jones, T. L. *Ballistic Performance of Titanium Alloys Ti-6Al-4V Versus Russian Titanium*; ARL-CR-0533, U.S. Army Research Laboratory: Aberdeen Proving Ground, MD, February 2004.
5. U.S. Army Research Laboratory. *Projectile, Calibers .22, .30, .50, and 20-mm Fragment-Simulating*; Military Specification MIL-DTL-46593B (MR); Aberdeen Proving Ground, MD, 06 July 2006.
6. U.S. Army Research Laboratory. *V₅₀ Ballistic Test for Armor*; Military Standard MIL-STD-662F; Aberdeen Proving Ground, MD, 18 December 1997.

NO. OF
COPIES ORGANIZATION

1 DEFENSE TECHNICAL
(PDF INFORMATION CTR
ONLY) DTIC OCA
8725 JOHN J KINGMAN RD
STE 0944
FORT BELVOIR VA 22060-6218

1 US ARMY RSRCH DEV & ENG CMD
SYSTEMS OF SYSTEMS INTEGRATION
AMSRD SS T
6000 6TH ST STE 100
FORT BELVOIR VA 22060-5608

1 DIRECTOR
US ARMY RESEARCH LAB
IMNE ALC IMS
2800 POWDER MILL RD
ADELPHI MD 20783-1197

1 DIRECTOR
US ARMY RESEARCH LAB
AMSRD ARL CI OK TL
2800 POWDER MILL RD
ADELPHI MD 20783-1197

2 DIRECTOR
US ARMY RESEARCH LAB
AMSRD ARL CS OK T
2800 POWDER MILL RD
ADELPHI MD 20783-1197

4 CDR US ARMY TACOM
ATTN AMSTA TR S T FURMANIAK
L PROKURAT FRANKS
D TEMPLETON
MS 263
WARREN MI 48397-5000

1 CDR US ARMY TACOM
ATTN AMSRD TAR R D HANSEN
MS 271
WARREN MI 48397-5000

1 PM
ATTN SFAE GCSS HBCTS JROWE
MS 325
WARREN MI 48397-5000

2 CDR NGIC
ATTN J CRIDER W GSTATTENBAUER
2055 BOULDERS RD
CHARLOTTESVILLE VA 22911-8318

NO. OF
COPIES ORGANIZATION

1 CRUSADER OPM
ATTN SFAE GCSS CR E B ROOPCHAND
BLDG 171A
PICATINNY ARSENAL NJ 07806-5000

1 DIRECTOR
DARPA
3701 NORTH FAIRFAX DR
ARLINGTON VA 22203-1714

1 PM BFVS
ATTN SFAE GCSS W BV S M KING
WARREN MI 48397-5000

1 CDR CARDEROCK DIV NSWC
ATTN CODE 28 R PETERSON
9500 MACARTHUR BLVD
W BETHESDA MD 20817-5700

2 LAWRENCE LIVERMORE NATL LAB
ATTN R LANDINGHAM L372
J REAUGH L282
PO BOX 808
LIVERMORE CA 94550

2 LOS ALAMOS NATL LAB
ATTN F ADDESSIO M BURKETT
PO BOX 1663
LOS ALAMOS NM 87545

1 NAVAL RSCH LABORATORY
ATTN CODE 6684
4555 OVERLOOK AVE SW
WASHINGTON DC 20375

5 SANDIA NATL LAB
ATTN J ASAY MS 1811
R BRANNON MS 0751
L CHHABILDAS MS 1811
D CRAWFORD MS 0836, 9116
M FORRESTAL DIV 1551
PO BOX 5800
ALBUQUERQUE NM 87185-0307

1 AIR FORCE ARMAMENT LAB
ATTN AFATL DLJW W COOK
EGLIN AFB FI 32542

4 INST FOR ADVNCD TECH
ATTN S BLESS H FAIR J HODGE
R SUBRAMANIAN
3925 W BRAKER LANE
AUSTIN TX 78759-5316

NO. OF
COPIES ORGANIZATION

1 UNIV OF DAYTON RSCH INST
ATTN KLA 14 N BRAR
300 COLLEGE PARK
DAYTON OH 45469-0182

3 SOUTHWEST RSCH INST
ATTN C ANDERSON J RIEGEL
J WALKER
6220 CULEBRA RD
SAN ANTONIO TX 78238

4 US DEPT OF ENERGY
ALBANY RSCH CENTER
ATTN J HANSEN (2 CYS)
P TURNER (2 CYS)
1450 QUEEN AVE SW
ALBANY OR 97321-2198

1 BROWN UNIV
DIV OF ENGINEERING
ATTN R CLIFTON
PROVIDENCE RI 02912

2 UNIV OF CA SAN DIEGO
DEPT OF APPL MECH & ENGR
SVC RO11
ATTN S NEMAT NASSER M MEYERS
LA JOLLA CA 92093-0411

2 AERONAUTICAL RSCH ASSN
ATTN R CONTILIANO J WALKER
PO BOX 2229
50 WASHINGTON RD
PRINCETON NJ 08540

1 ALLIANT TECHSYSTEMS INC
ATTN G JOHNSON
5050 LINCOLN DR
EDINA MN 55436

1 APPLIED RSCH ASSN INC
ATTN D GRADY
4300 SAN MATEO BLVD NE STE A
ALBUQUERQUE NM 87110

1 BRIGGS COMPANY
ATTN J BACKOFEN
2668 PETERSBOROUGH ST
HERNDON VA 222071-2443

3 CERCOM
ATTN R PALICKA G NELSON B CHEN
1960 WATSON WAY
VISTA CA 92083

NO. OF
COPIES ORGANIZATION

1 CYPRESS INTERNTL
ATTN A CAPONECCHI
1201 E ABINGDON DR
ALEXANDRIA VA 22314

1 R J EICHELBERGER
409 W CATHERINE ST
BEL AIR MD 21014-3613

1 EPSTEIN AND ASSN
ATTN K EPSTEIN
2716 WEMBERLY DR
BELMONT CA 94002

1 GENERAL RSCH CORP
PO BOX 6770
SANTA BARBARA CA 93160-6770

3 GDLS
ATTN W BURKE MZ436 21 24
G CAMPBELL MZ436 30 44
D DEBUSSCHER MZ436 20 29
38500 MOUND RD
STERLING HTS MI 48310-3200

3 GDLS
ATTN J ERIDON MZ436 21 24
W HERMAN MZ435 01 24
S PENTESCU MZ436 21 24
38500 MOUND RD
STERLING HTS MI 48310-3200

1 INTERNATL RSCH ASSN
ATTN D ORPHAL
4450 BLACK AVE
PLEASANTON CA 94566

1 JET PROPULSION LAB
IMPACT PHYSICS GROUP
ATTN M ADAMS
4800 OAK GROVE DR
PASADENA CA 91109-8099

3 OGARA HESS & EISENHARDT
ATTN G ALLEN D MALONE
T RUSSELL
9113 LE SAINT DR
FAIRFIELD OH 45014

2 ALLVAC OREMET FACILITY
ATTN J KOSIN B MAHONEY
530 34TH AVE SW
PO BOX 460
ALBANY OR 97321

NO. OF
COPIES ORGANIZATION

4 POULTER LABORATORY
SRI INTERNATIONAL
ATTN D CURRAN R KLOOP
L SEAMAN D SHOCKEY
333 RAVENSWOOD AVE
MENLO PARK CA 94025

6 RMI TITANIUM CO
ATTN J BENNETT E CHRIST
F JANOWSKI W PALLANTE
S ROBERTSON O YU
1000 WARREN AVE
NILES OH 44446

1 TIMET
ATTN J FANNING
PO BOX 2128
HENDERSON NV 89009

1 TWIST
ATTN J BARBER
1999 BROADWAY STE 4300
DENVER CO 80202

1 SIMULA INC
ATTN R WOLFFE
10016 SOUTH 51 ST ST
PHOENIX AZ 85044

3 UNITED DEFENSE LP
ATTN E BRADY R JENKINS
K STRTTMATTER
PO BOX 15512
YORK PA 17405-1512

1 ZERNOW TECH SVCS INC
ATTN L ZERNOW
425 W BONITA AVE STE 208
SAN DIMAS CA 91773

1 PENN STATE UNIV
ATTN DAVE SWANSON
504L APPLIED SCIENCE BLDG
STATE COLLEGE PA 16802

5 MENA
ATTN RICK DeLORME
1001 COLLEGE STREET
PO BOX 258
MADISON IL 62060

NO. OF
COPIES ORGANIZATION

1 APPLIED RSCH LAB
ACOUSTICS PROGRAM
ATTN D SWANSON
504L APPLIED SCI BLDG
UNIVERSITY PK PA 16803

1 RITA JONES
80 PALISADE AVE
WHITE PLAINS NY 10607

1 CHARLIA CONYERS
2412 HAY RAKE CT
HERNDON VA 20171

1 RECHELLE JACKSON
426 WASHINGTON ST
ABERDEEN MD 21001

1 TIAX LLC
ATTN JACOB PRETORIUS
15 ACORN PARK
CAMBRIDGE MA 02140

1 UNIV OF VIRGINIA
DEPT OF MATERIALS SCI & ENG
SCHOOL OF ENG & APPL SCIENCE
ATTN HAYDN WADLEY
B214 THORNTON HALL
116 ENGINEERS WAY
CHARLOTTESVILLE VA 22903

1 PACIFIC NORTHWEST NAIL LAB
ATTN ERIC NYBERG
MSIN P7-82
902 BATTELLE BLVD
RICHLAND WA 99352

1 CELLULAR MATERIALS INTERNATL INC
ATTN YELLAPU MURTY
2 BOARS HEAD LANE
CHARLOTTESVILLE VA 22903

1 EMBASSY OF AUSTRALIA
COUNSELLOR DEFENCE SCIENCE
1601 MASSACHUSETTS AVE NW
WASHINGTON DC 20036-2273

ABERDEEN PROVING GROUND

1 DIRECTOR
US ARMY RSCH LABORATORY
ATTN AMSRD ARL CI OK (TECH LIB)
BLDG 4600

NO. OF
COPIES ORGANIZATION

1 DIR USA EBCC
ATTN SCBRD RT
5183 BLACKHAWK RD
APG EA MD 21010-5424

1 CDR USA SBCCOM
ATTN AMSCB CII
5183 BLACKHAWK RD
APG EA MD 21010-5424

1 DIR USAMSA
ATTN AMXSY D
BLDG 392

1 CDR USATEC
ATTN STEAC LI LV E SANDERSON
BLDG 400

1 CDR US ARMY DTC
ATTN CSTE DTC TT T M SIMON
RYAN BLDG

2 DIR USARL
ATTN AMSRD ARL SL BM A DIETRICH
AMSRD ARL SL BE W BRUCHEY
BLDG 328

9 DIR USARL
ATTN AMSRD ARL D J MILLER
V WEISS
AMSRD ARL WM J SMITH
J McCAULEY P PLOSTINS
T WRIGHT
AMSRD ARL WM B M ZOLTOSKI
AMSRD ARL WM BD D LOWRY
AMSRD ARL WM BF S WILKERSON

13 DIR USARL
ATTN AMSRD ARL WM M J BEATTY
S McKNIGHT B DOWDING
AMSRD ARL WM MB R CARTER
L KECSKES S MATHAUDHU
D SNOHA
AMSRD ARL WM MC W ROY
R SQUILLACIOTI
AMSRD ARL WM MD E CHIN
B CHEESEMAN K CHO
J MONTGOMERY

NO. OF
COPIES ORGANIZATION

30 DIR USARL
ATTN AMSRD ARL WM T B BURNS
P BAKER
AMSRD ARL WM TA C HOPPEL
M BURKINS (5 CYS)
W GOOCH (5 CYS) T HAVEL
D HACKBARTH E HORWATH
T JONES (10 CYS) D KLEPONIS
B LEAVY J RUNYEON
S SCHOENFELD

13 DIR USARL
ATTN AMSRD ARL WM TB R BANTON
R GUPTA
AMSRD ARL WM TC R COATES
R ANDERSON T FARRAND
K KIMSEY D SCHEFFLER
L MAGNESS R MUDD
S SCHRAML S SEGLETES
R SUMMERS W WALTERS

13 DIR USARL
ATTN AMSRD ARL WM TD S BILYK
T BJERKE D CASEM
J CLAYTON D DANDEKAR
M GREENFIELD Y HUANG
B LOVE H MEYER
M RAFTENBERG E RAPACKI
M SCHEIDLER T WEERASOORIYA

1 DIR USARL
ATTN AMSRD ARL WM TE C HUMMER
BLDG 1116A

NO. OF
COPIES ORGANIZATION

FOREIGN ADDRESSES

2 AERONAUTICAL & MARITIME
RSCH LAB
N MURMAN S C1MPOERU D PAUL
PO BOX 4331
MELBOURNE VIC 3001
AUSTRALIA

1 ARMSCOR
L DU PLESSIS
PRIVATE BAG X337
PRETORIA 0001
SOUTH AFRICA

1 DEFENCE RSCH AGENCY
FORT HALSTEAD SEVEN OAKS
KENT TN 14 7BP
UNITED KINGDOM

1 CARLOS III UNIV OF MADRID
C NAVARRO
ESCUELA POLTEENICA SUPERIOR
C/BUTARQUE 15
28911 LEGANES MADRID
SPAIN

1 CELIUS MATERIAL TEKNIK
KARLSKOGA AB
L HELLNER
S 69180 KARLSKOGA
SWEDEN

3 CENTRE D'ETUDES GRAMAT
J CAGNOUX C GALLIC
J TRANCHET
GRAMAT 46500
FRANCE

1 MINISTRY OF DEFENCE
DGA DSP STTC G BRAULT
4 RUE DE LA PORTE D'ISSY
00460 ARMEES
F 75015 PARIS
FRANCE

1 CONDAT
J KIERMEIR
MAMLANSTR 28
8069 SCHEYERN FERNHAG
GERMANY

NO. OF
COPIES ORGANIZATION

1 OSAKA UNIVERSITY
JOINING & WELDING RSCH INST
ATTN DR KATSUYOSHI KONDOH
11-1 MIHOGAOAKA IBARAKI
OSAKA 567-0047 JAPAN

2 DEFENCE PROCUREMENT AGCY
G LAUBE W ODERMATT
BALLISTICS WPNS & COMBAT
VEHICLE TEST CTR
CH 3602 THUN
SWITZERLAND

1 TDW
M HELD
POSTFACH 1340
D 86523 SCHROBENHAUSEN
GERMANY

4 DEFENSE RSCH AGENCY
W CARSON T HAWKINS B JAMES
B SHRUBSALL
PORTON DOWN
SALISBURY WTTTS SP 04 OJQ
UNITED KINGDOM

1 DEFENCE RSCH ESTAB
VALCARTIER ARMAMENTS DIV
R DELAGRAVE
2459 PIE XI BLVD N
PO BOX 8800
CORCELETTE QUEBEC GOA IRO
CANADA

2 DEUTSCH FRANZOSISCHES
FORSCHUNGSINSTITUT ST LOUIS
H ERNST H LERR
CEDEX 5 RUE DU
GENERAL CASSAGNOU
F 68301 SAINT LOUIS
FRANCE

1 DIEHL GMBH AND CO
M SCHILDKNECHT
FISCHBACHSTRASSE 16
D 90552 ROTBENBACH AD
PEGNITZ
GERMANY

1 DYNAMEC RSCH AB
A PERSSON
PARADESGRND7
SODERTALJE S151 36
SWEDEN

NO. OF
COPIES ORGANIZATION

- 2 ETBS DSTI
P BARNIER M SALLES
ROUTE DE GUERAY
BOITE POSTALE 712
18015 BOURGES CEDEX
FRANCE
- 1 FEDERAL MINISTRY OF DEFENCE
DIR OF EQPT & TECH LAND
RUV 2
D HAUG
POSTFACH 1328
53003 BONN
GERMANY
- 4 FRANHOFER INSTITUT FUR
KURZZEITDYNAMIK
ERNST MACH INSTITUT
V HOHLER E STRASSBURGER
R TRAM K THOMA
ECKERSTRASSE4
D 79 104 FREIBURG
GERMANY
- 1 MINISTRY OF DEFENCE
DGA/SPART
C CANNAVO
10 PLACE GEORGES CLEMENCEAU
BP 19
F 92211 SAINT CLOUD CEDEX
FRANCE
- 1 HIGH ENERGY DENSITY RSCH CTR
V FORTOV G KANEL
IZHORSKAY STR 13/19
MOSCOW 127412
RUSSIAN REPUBLIC
- 1 INGENIEURBURO DEISENROTH
F DEISENROTH
AUF DE HARDT 33 35
D 5204 LOHMAR 1
GERMANY
- 1 INST OF CHEMICAL PHYSICS
S RAZORENOV
142432 CHERNOGOLOVKA
MOSCOW REGION
RUSSIAN REPUBLIC

NO. OF
COPIES ORGANIZATION

- 7 INST FOR PROBLEMS IN MATLS SCI
S FIRSTOV B GALANOV O GRIGORIEV
V KARTUZOV V KOVTUN Y MILMAN
V TREFILOV
3 KRHYZHANOVSKY STR
252142 KIEV 142
UKRAINE
- 1 INST FOR PROBLEMS
OFSTRENGTH
G STEPANOV
TIMIRY AZEVSKAYA STR 2
252014 KIEV
UKRAINE
- 3 INST OF MECH ENGR PROBLEMS
V BULATOV D INDEITSEV
Y MESHCHERYAKOV
BOLSHOY 61 VO
ST PETERSBURG 199178
RUSSIAN REPUBLIC
- 2 IOFFE PHYSICO TECH INST
E DROBYSHEVSKI A KOZHUSHKO
ST PETERSBURG 194021
RUSSIAN REPUBLIC
- 1 R OGORKIEWICZ
18 TEMPLE SHEEN
LONDON SW 14 7RP
UNITED KINGDOM
- 2 NATL DEFENCE HDQRTRS
PMO MRCV MAJ PACEY
PMO LAV A HODAK
OTTOWA ONTARIO KIA OK2
CANADA
- 1 OTO BRED A
M GUALCO
VIA VALDIOCCHI 15
119136 LA SPEZIA
ITALY
- 5 RAPHAEL BALLISTICS CTR
M MAYSELESS Y PARTOM
G ROSENBERG Z ROSENBERG
Y YESHURUN
BOX 2250
HAIFA 31021
ISRAEL

NO. OF
COPIES ORGANIZATION

- 1 ROYAL MILITARY ACADEMY
E CELENS
RENAISSANCE AVE 30
B 1040 BRUSSELS
BELGIUM

- 1 ROYAL NETHERLANDS ARMY
JHOENEVELD
V D BURCHLAAN 31
PO BOX 90822
2509 LS THE HAGUE
NETHERLANDS

- 1 DEFENCE MATERIEL ADMIN
WEAPONS DIRECTORATE
A BERG
S 11588 STOCKHOLM
SWEDEN

- 2 CENTRE DE RECHERCHES
ET D'ETUDES D'ARCUEIL
D BOUVART C COTTENNOT
16 BIS AVENUE PRIEUR DE
LA COTE D'OR
F 94114 ARCUEIL CEDEX
FRANCE